

MSKSEMI

SEMICONDUCTOR



ESD



TVS



TSS



MOV



GDT



PLED

Product data sheet

◆ **DEVICE DESCRIPTION**

The TL432/TL432R is a three-terminal adjustable shunt regulator highly accurate 1.25V bandgap reference with a 0.5% tolerance. The device offers thermal stability, wide operating current (50mA) and an extended temperature range of 0 to 105°C for operation in power supply applications. The TL432/TL432R offers a wide operating voltage range of up to 18V and is an excellent choice for voltage reference requirements in an isolated feedback circuit for 3.0V to 3.3V switching mode power supplies. The tight tolerance guarantees a lower design cost for the power supply manufacturer by virtually eliminating the need for an extra power supply manufacturing process of the power supply.

◆ **Features**

- Wide Programmable Output Voltage from 1.25V to 18V.
- Low Dynamic Output Resistance: 0.05Ω Typical.
- High Sink Current Capacity from 55uA-100mA.
- Low Equivalent Full-Range Temperature Coefficient : 20PPM/°C Typical.
- Wide Operating Range of -40 to 125°C.



◆ **Absolute Maximum Ratings (Ta=25°C)**

Symbol	Parameter	Value	Unit
V _{KA}	Cathode Voltage	18	V
I _{KA}	Cathode Current Range (Continuous)	100	mA
I _{ref}	Reference Input Current Range	6	μA
P _D	Power Dissipation	350	mW
R _{θJA}	Thermal Resistance From Junction To Ambient	357	°C/W
T _J , T _{stg}	Operation Junction And Storage Temperature Range	-40~+125	°C

◆ **Electrical Characteristics (Ta=25°C unless otherwise specified)**

Symbol	Parameter	Test conditions	Min	Typ	Max	Unit
V _{ref}	Reference input voltage	V _{KA} =V _{REF} , I _{KA} =10mA	1.225		1.275	V
ΔV _{ref} /ΔT	Deviation of reference input voltage over temperature (note)	V _{KA} =V _{REF} , I _{KA} =10mA, T _{MIN} ≤Ta≤T _{MAX}		4.5	16	mV
ΔV _{ref} /ΔV _{KA}	Ratio of change in reference input voltage to the change in cathode voltage	I _{KA} =10mA, ΔV _{KA} = 1.25V~18V			2.4	mV/V
I _{ref}	Reference input current	I _{KA} =10mA, R1=10KΩ, R2=∞			0.5	μA
ΔI _{ref} /ΔT	Deviation of reference input current over full temperature range	I _{KA} =10mA, R1=10KΩ, R2=∞, T _A =0 to 70°C			0.6	μA
I _{KA(min)}	Minimum cathode current for regulation	V _{KA} =V _{REF}			0.1	mA
I _{KA(OFF)}	Off-state cathode current	V _{KA} =36V, V _{REF} =0			0.5	μA
Z _{KA}	Dynamic impedance	V _{KA} =V _{REF} , I _{KA} =1~100mA, f≤1.0KHz			0.5	Ω

◆ **Classifications of V_{ref}**

Rank	±0.5%	±1%
Range	1.244~1.256	1.238~1.262

◆ **Marking**

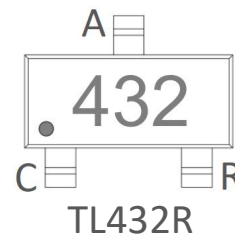
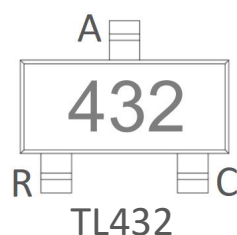

◆ **Typical Characteristics**

Cathode Current versus Cathode Voltage

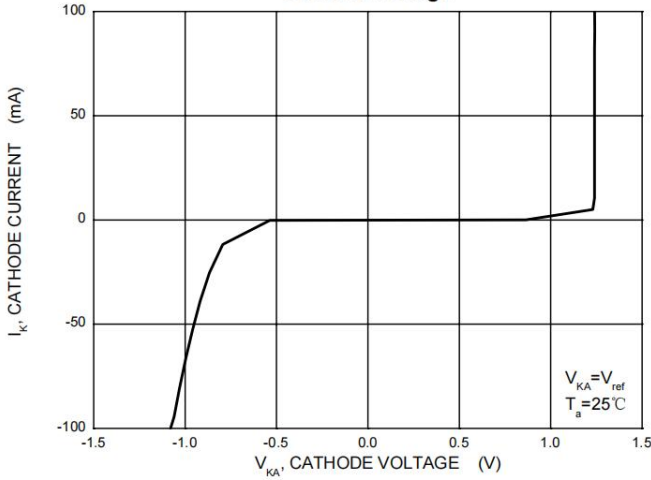

Cathode Current versus Cathode Voltage

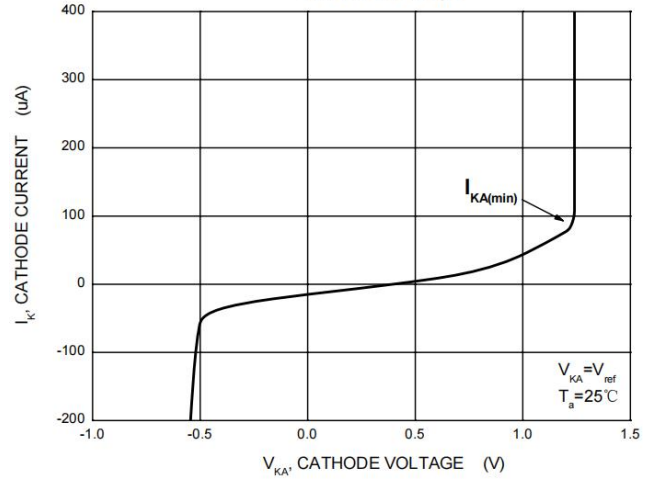

Reference Input Voltage versus Ambient Temperature

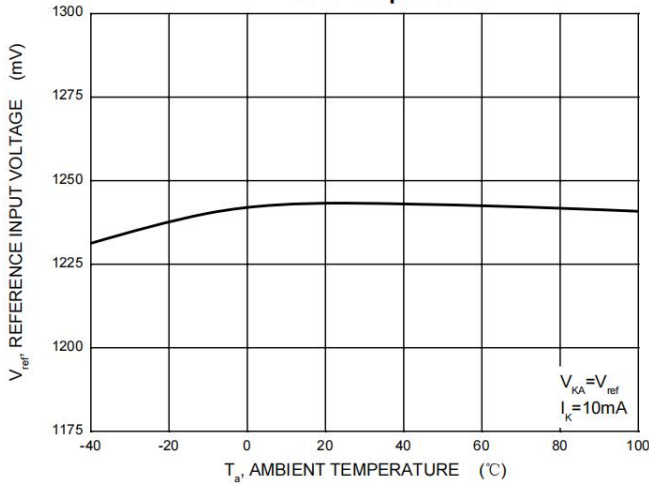

Change in Reference Input Voltage versus Cathode Voltage

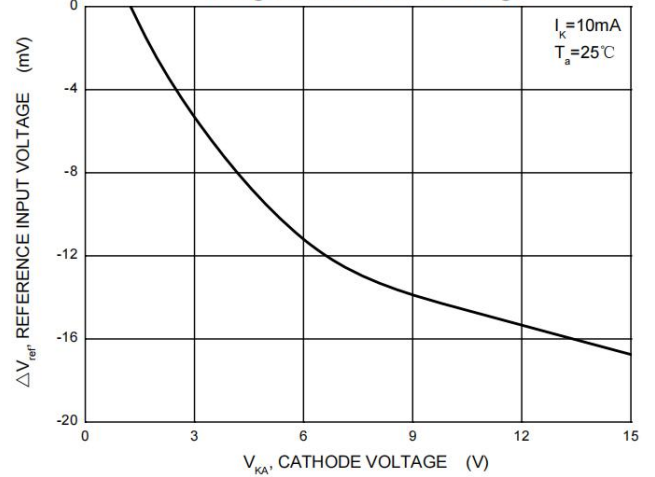

Reference Input Current versus Ambient Temperature

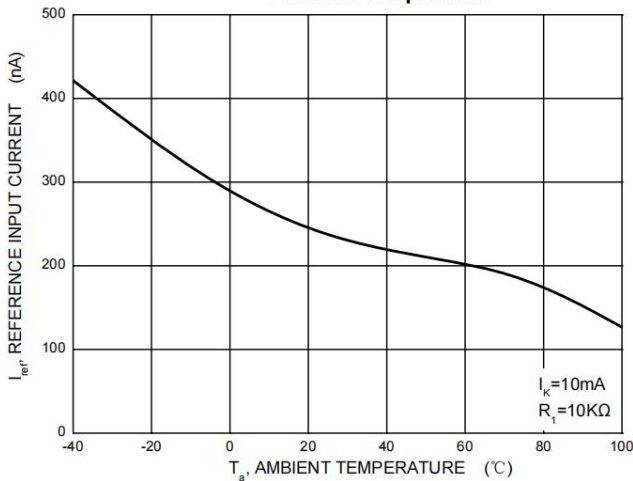

Off-State Cathode Current versus Ambient Temperature

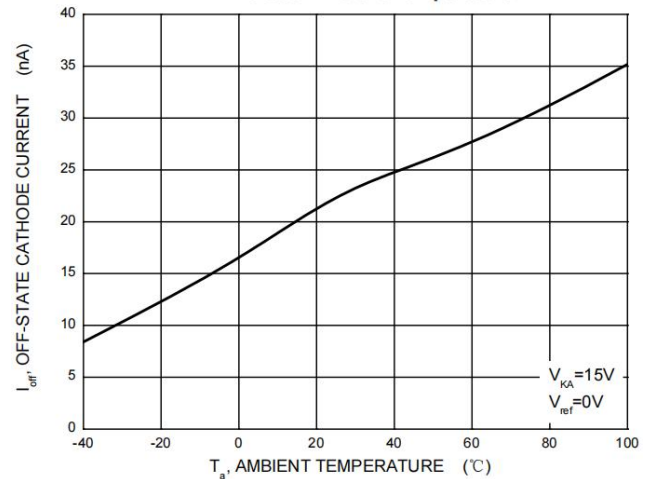

PACKAGE MECHANICAL DATA

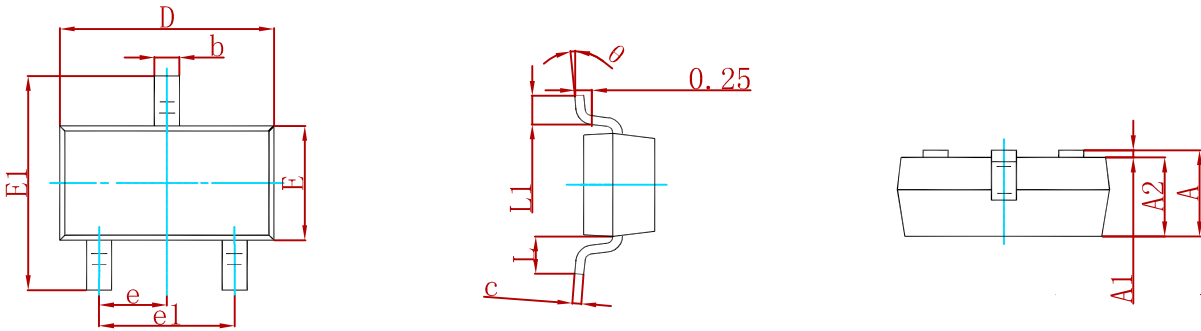

Symbol	Dimensions In Millimeters		Dimensions In Inches	
	Min	Max	Min	Max
A	0.900	1.150	0.035	0.045
A1	0.000	0.100	0.000	0.004
A2	0.900	1.050	0.035	0.041
b	0.300	0.500	0.012	0.020
c	0.080	0.150	0.003	0.006
D	2.800	3.000	0.110	0.118
E	1.200	1.400	0.047	0.055
E1	2.250	2.550	0.089	0.100
e	0.950 TYP		0.037 TYP	
e1	1.800	2.000	0.071	0.079
L	0.550 REF		0.022 REF	
L1	0.300	0.500	0.012	0.020
θ	0°	8°	0°	8°

Suggested Pad Layout

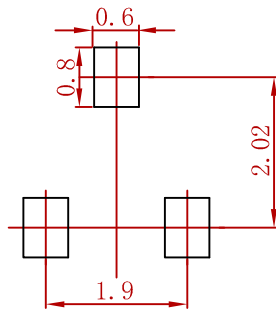

- Note:
1. Controlling dimension: in millimeters.
 2. General tolerance: ± 0.05mm.
 3. The pad layout is for reference purposes only.

REEL SPECIFICATION

P/N	PKG	QTY
TL432/TL432R	SOT-23	3000

Attention

- Any and all MSKSEMI Semiconductor products described or contained herein do not have specifications that can handle applications that require extremely high levels of reliability, such as life-support systems, aircraft's control systems, or other applications whose failure can be reasonably expected to result in serious physical and/or material damage. Consult with your MSKSEMI Semiconductor representative nearest you before using any MSKSEMI Semiconductor products described or contained herein in such applications.
- MSKSEMI Semiconductor assumes no responsibility for equipment failures that result from using products at values that exceed, even momentarily, rated values (such as maximum ratings, operating condition ranges, or other parameters) listed in products specifications of any and all MSKSEMI Semiconductor products described or contained herein.
- Specifications of any and all MSKSEMI Semiconductor products described or contained herein stipulate the performance, characteristics, and functions of the described products in the independent state, and are not guarantees of the performance, characteristics, and functions of the described products as mounted in the customer's products or equipment. To verify symptoms and states that cannot be evaluated in an independent device, the customer should always evaluate and test devices mounted in the customer's products or equipment.
- MSKSEMI Semiconductor strives to supply high-quality high-reliability products. However, any and all semiconductor products fail with some probability. It is possible that these probabilistic failures could give rise to accidents or events that could endanger human lives, that could give rise to smoke or fire, or that could cause damage to other property. When designing equipment, adopt safety measures so that these kinds of accidents or events cannot occur. Such measures include but are not limited to protective circuits and error prevention circuits for safe design, redundant design, and structural design.
- In the event that any or all MSKSEMI Semiconductor products (including technical data, services) described or contained herein are controlled under any of applicable local export control laws and regulations, such products must not be exported without obtaining the export license from the authorities concerned in accordance with the above law.
- No part of this publication may be reproduced or transmitted in any form or by any means, electronic or mechanical, including photocopying and recording, or any information storage or retrieval system, or otherwise, without the prior written permission of MSKSEMI Semiconductor.
- Information (including circuit diagrams and circuit parameters) herein is for example only ; it is not guaranteed for volume production. MSKSEMI Semiconductor believes information herein is accurate and reliable, but no guarantees are made or implied regarding its use or any infringement of intellectual property rights or other rights of third parties.
- Any and all information described or contained herein are subject to change without notice due to product/technology improvement, etc. When designing equipment, refer to the "Delivery Specification" for the MSKSEMI Semiconductor product that you intend to use.