

MSKSEMI

SEMICONDUCTOR

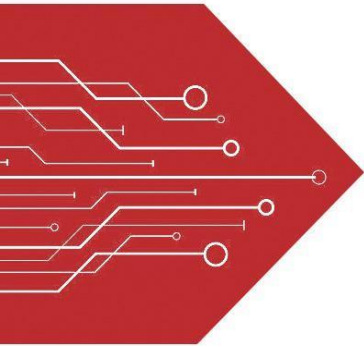

ESD



TVS



TSS



MOV



GDT



PLED

Product data sheet

Features

- Protects two or four I/O lines
- Low capacitance: 0.5pF Typical between I/O channel
- Low leakage current
- 5V operating voltage
- Response time < 1ns
- Solid-state silicon avalanche technology
- Device meets MSL 1 requirements
- RoHS compliant

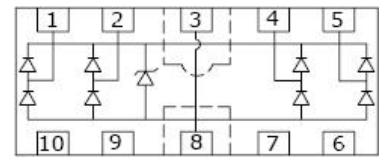

DFN2510

Applications

- High Definition Multi-Media Interface (HDMI)
- Digital Visual Interface (DVI)
- USB 1.1/2.0/3.0/OTG
- IEEE 1394 Firewire Ports
- Notebooks & Handhelds
- Projection TV & Monitors
- Set-top box
- Flat Panel Displays
- PCI Express

Mechanical Characteristics

- DFN2510 package
- Flammability Rating: UL 94V-0
- Terminal: Matte tin plated.
- Packaging: Tape and Reel
- High temperature soldering guaranteed: 260°C/10s
- Reel size: 7 inch

Maximum Ratings And Characteristics @ 25°C Ambient Temperature (unless otherwise noted)

Symbol	Parameter	Value	Units
P _{PP}	Peak Pulse Power (8/20μs)	150	W
I _{PP}	Peak Pulse Current (8/20μs)	5	A
V _{ESD}	ESD per IEC 61000-4-2 (Air) ESD per IEC 61000-4-2 (Contact)	±15 ±8	kV
T _{OPT}	Operating Temperature	-55/+150	°C
T _{STG}	Storage Temperature	-55/+150	°C

Electrical Characteristics(T_{amb}=25°C)

Symbol	Parameter	Test Condition	Min	Typ	Max	Units
V _{RWM}	Reverse Working Voltage	Any I/O pin to GND			5.0	V
V _{BR}	Reverse Breakdown Voltage	I _T = 1mA Any I/O pin to GND	6.0			V
I _R	Reverse Leakage Current	V _{RWM} = 5V Any I/O pin to GND			1	μA
V _F	Diode Forward Voltage	I _F = 15mA		0.85	1.2	V
V _{C1}	Clamping Voltage 1	I _{PP} = 1A, t _p = 8/20μs Any I/O pin to GND			15.5	V
V _{C2}	Clamping Voltage 2	I _{PP} = 5, t _p = 8/20μs Any I/O pin to GND			25	V
C _{J1}	Junction Capacitance 1	V _R = 0V, f = 1MHz Between I/O pins		0.3	0.6	pF
C _{J2}	Junction Capacitance 2	V _R = 0V, f = 1MHz Any I/O pin to GND		0.45	0.8	pF

Note: I/O pins are pin 1,2,4,5.

Electrical Characteristics Curve

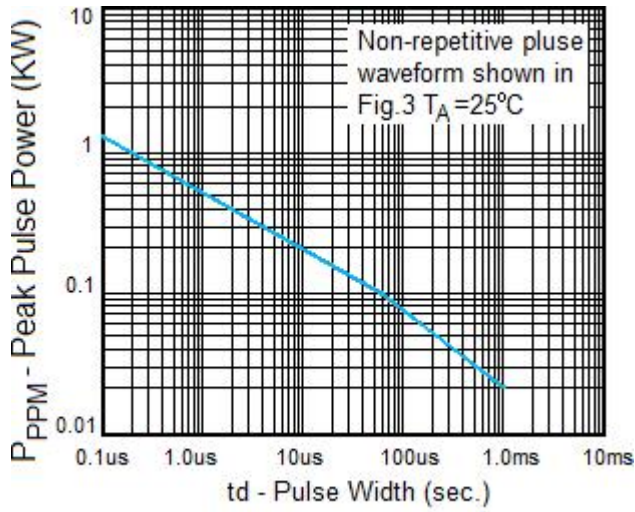

Fig. 1 Peak Pulse Power Rating

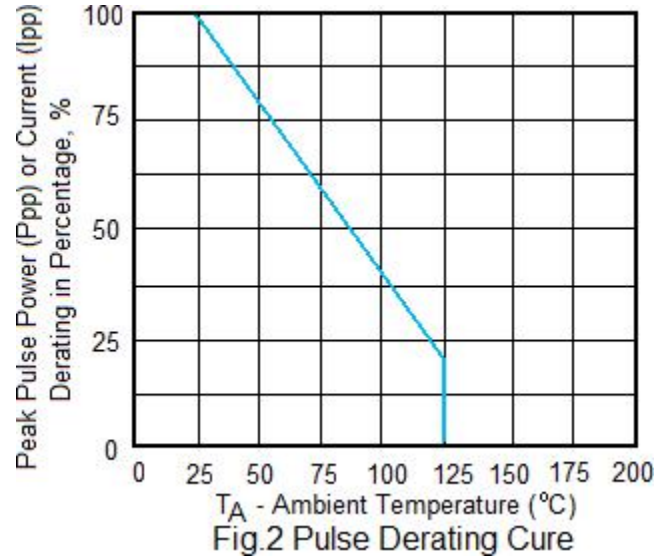

Fig. 2 Pulse Derating Curve

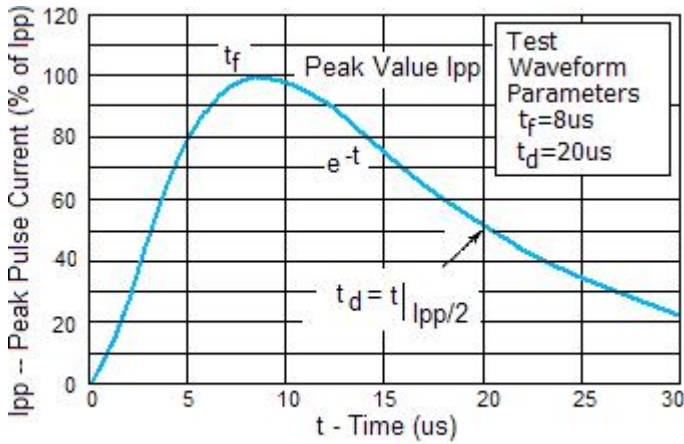

Fig. 3 Pulse Waveform

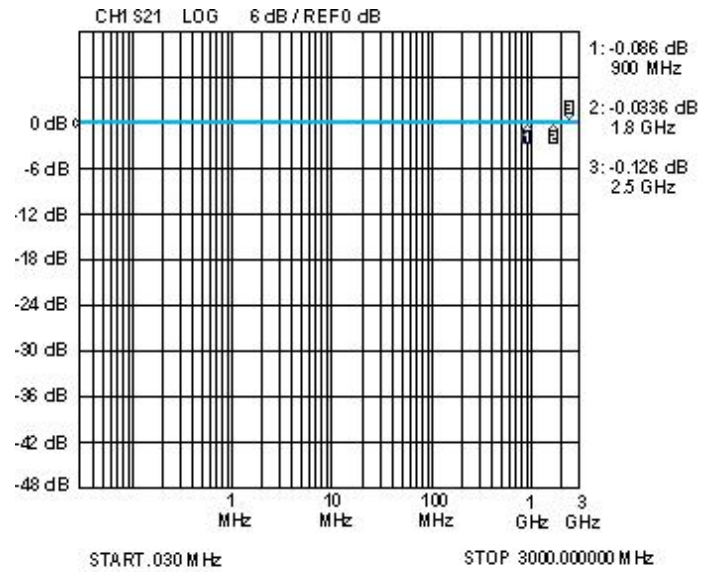
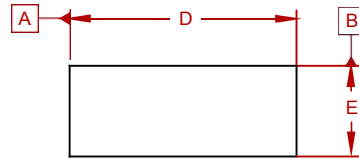
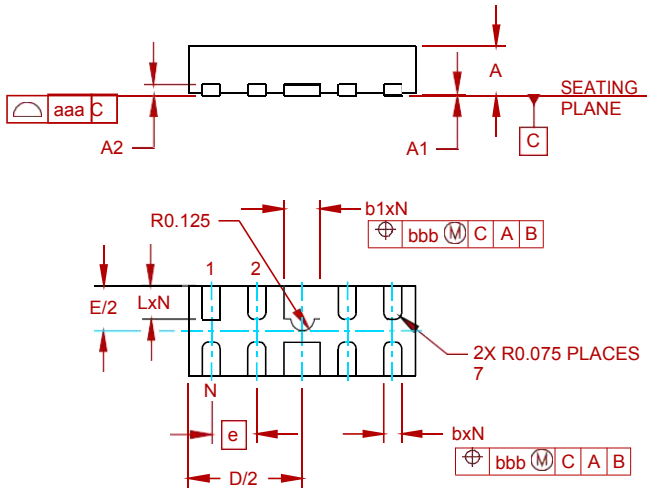

Fig. 4 Insertion Loss S21 - I/O to I/O

PACKAGE MECHANICAL DATA



DIM	DIMENSI ONS					
	INCHES			MILLIMETERS		
	MIN	NOM	MAX	MIN	NOM	MAX
A	.020	.023	.026	0.50	0.58	0.65
A1	0.00	.001	.002	0.00	0.03	0.05
A2	(.005)			(0.13)		
b	.006	.008	.010	0.15	0.20	0.25
b1	.014	.016	.018	0.35	0.40	0.45
D	.094	.098	.102	2.40	2.50	2.60
E	.035	.039	.043	0.90	1.00	1.10
e	.020 BSC			0.50 BSC		
L	.012	.015	.017	0.30	0.38	0.425
N	8			8		
aaa	.003			0.08		
bbb	.004			0.10		

Dimensions in millimeters

Suggested Pad Layout

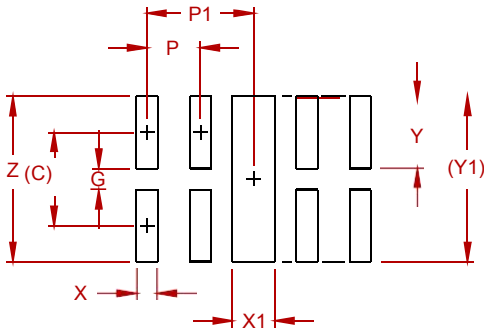

DIM	DIMENSIONS	
	INCHES	MILLIMETERS
C	(.034)	(0.875)
G	.008	0.20
P	.020	0.50
P1	.039	1.00
X	.008	0.20
X1	.016	0.40
Y	.027	0.675
Y1	(.061)	(1.55)
Z	.061	1.55

NOTES:

CONTROLLING DIMENSIONS ARE IN MILLIMETERS (ANGLES IN DEGREES).
THIS LAND PATTERN IS FOR REFERENCE PURPOSES ONLY.
CONSULT YOUR MANUFACTURING GROUP TO ENSURE YOUR COMPANY'S MANUFACTURING GUIDELINES ARE MET.

REEL SPECIFICATION

P/N	PKG	QTY
AZ1345-04F-MS	DFN2510	3000

Attention

- Any and all MSKSEMI Semiconductor products described or contained herein do not have specifications that can handle applications that require extremely high levels of reliability, such as life-support systems, aircraft's control systems, or other applications whose failure can be reasonably expected to result in serious physical and/or material damage. Consult with your MSKSEMI Semiconductor representative nearest you before using any MSKSEMI Semiconductor products described or contained herein in such applications.
- MSKSEMI Semiconductor assumes no responsibility for equipment failures that result from using products at values that exceed, even momentarily, rated values (such as maximum ratings, operating condition ranges, or other parameters) listed in products specifications of any and all MSKSEMI Semiconductor products described or contained herein.
- Specifications of any and all MSKSEMI Semiconductor products described or contained herein stipulate the performance, characteristics, and functions of the described products in the independent state, and are not guarantees of the performance, characteristics, and functions of the described products as mounted in the customer's products or equipment. To verify symptoms and states that cannot be evaluated in an independent device, the customer should always evaluate and test devices mounted in the customer's products or equipment.
- MSKSEMI Semiconductor strives to supply high-quality high-reliability products. However, any and all semiconductor products fail with some probability. It is possible that these probabilistic failures could give rise to accidents or events that could endanger human lives, that could give rise to smoke or fire, or that could cause damage to other property. When designing equipment, adopt safety measures so that these kinds of accidents or events cannot occur. Such measures include but are not limited to protective circuits and error prevention circuits for safe design, redundant design, and structural design.
- In the event that any or all MSKSEMI Semiconductor products (including technical data, services) described or contained herein are controlled under any of applicable local export control laws and regulations, such products must not be exported without obtaining the export license from the authorities concerned in accordance with the above law.
- No part of this publication may be reproduced or transmitted in any form or by any means, electronic or mechanical, including photocopying and recording, or any information storage or retrieval system, or otherwise, without the prior written permission of MSKSEMI Semiconductor.
- Information (including circuit diagrams and circuit parameters) herein is for example only ; it is not guaranteed for volume production. MSKSEMI Semiconductor believes information herein is accurate and reliable, but no guarantees are made or implied regarding its use or any infringements of intellectual property rights or other rights of third parties.
- Any and all information described or contained herein are subject to change without notice due to product/technology improvement, etc. When designing equipment, refer to the "Delivery Specification" for the MSKSEMI Semiconductor product that you intend to use.